

SCHOOL OBJECTS

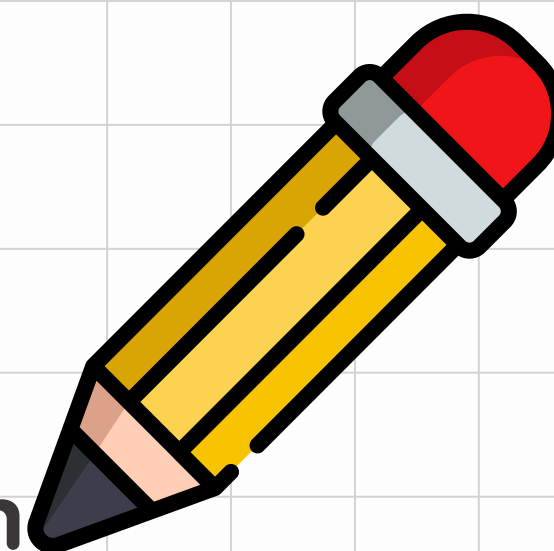
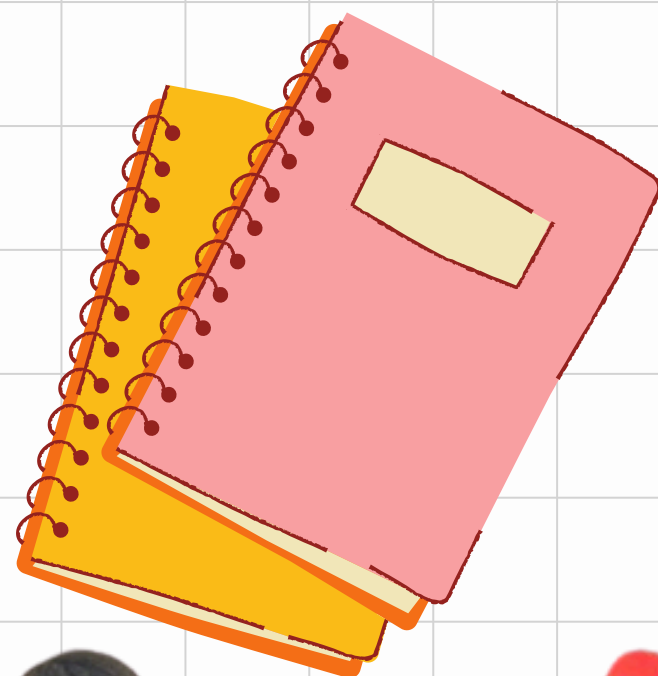

Teacher Patcharaporn Satasarn

Grade 3

Baansankamphaeng School

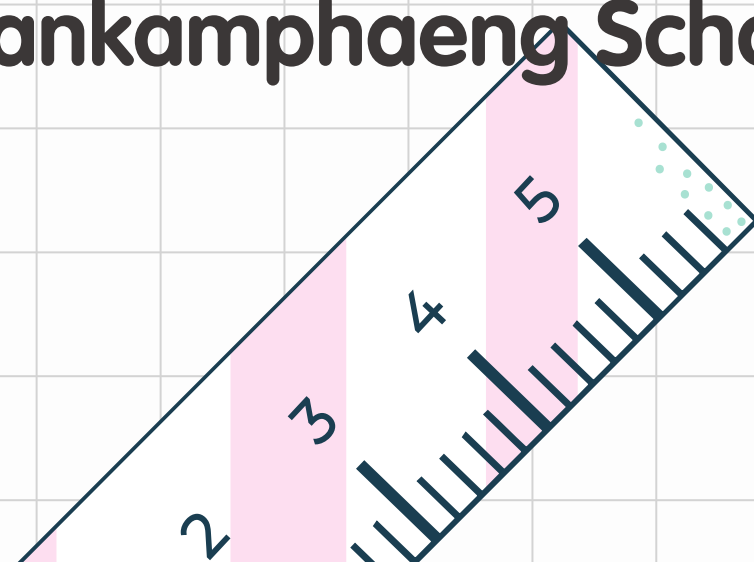
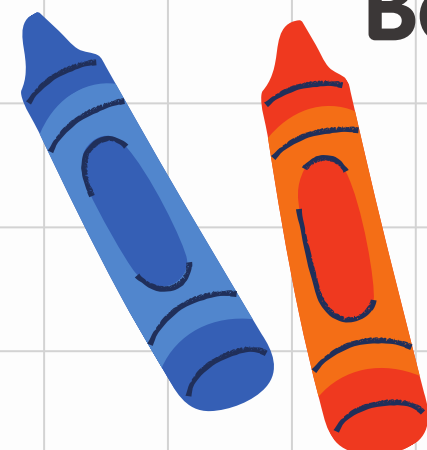

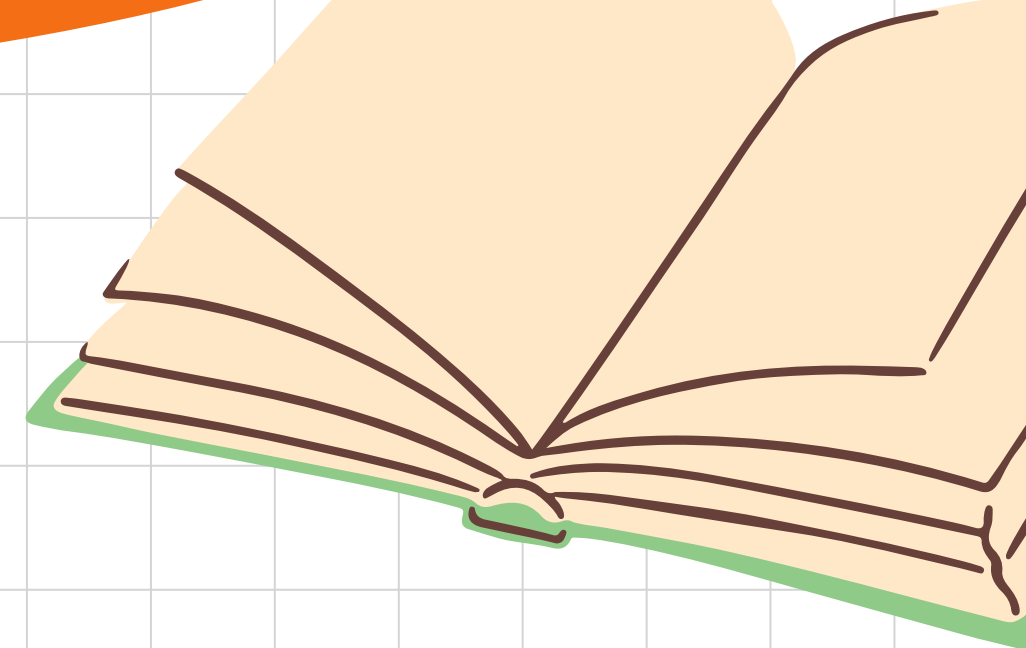
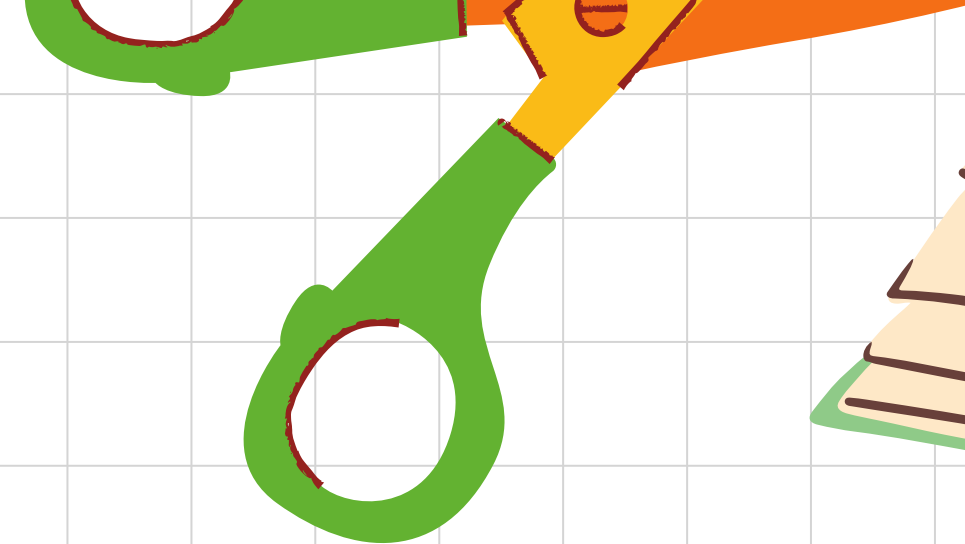
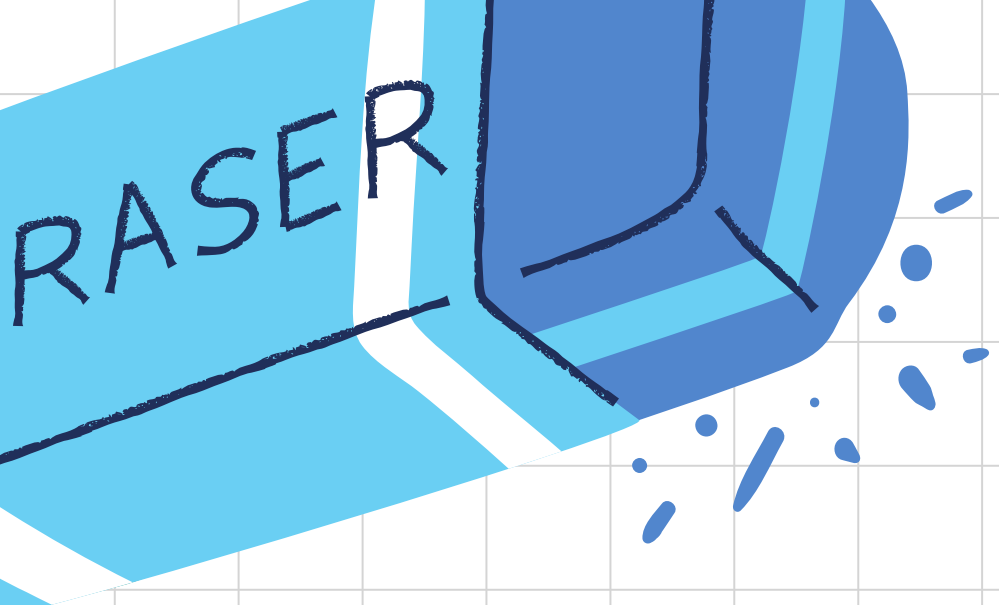

**CAN YOU
GUESS?**

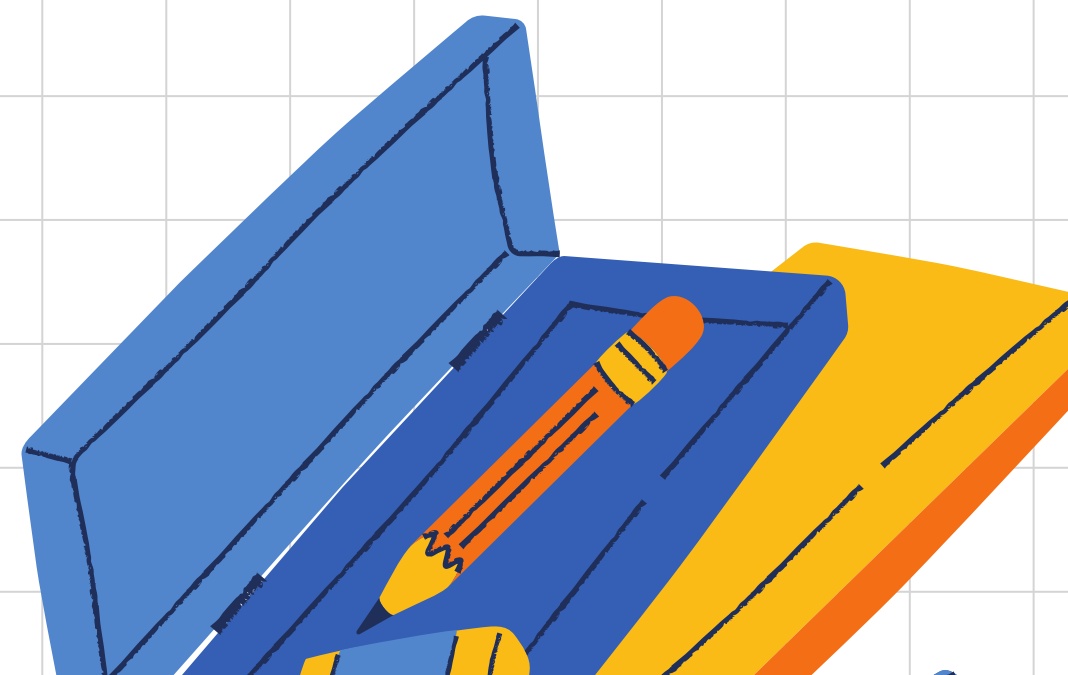
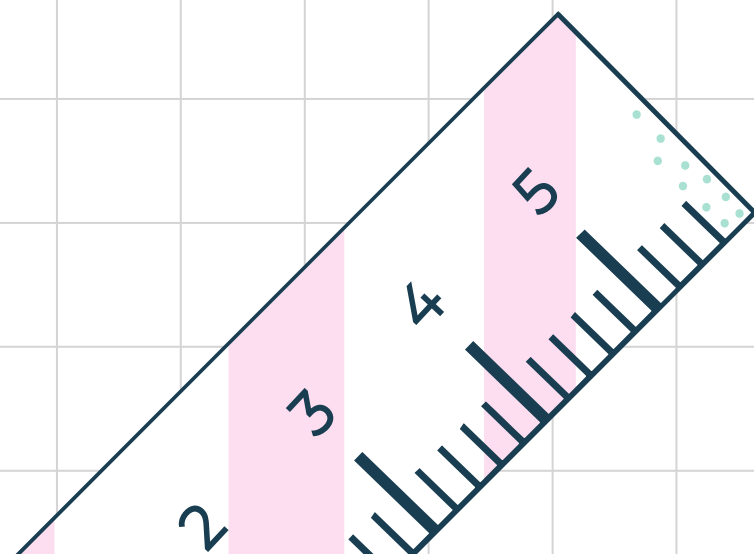
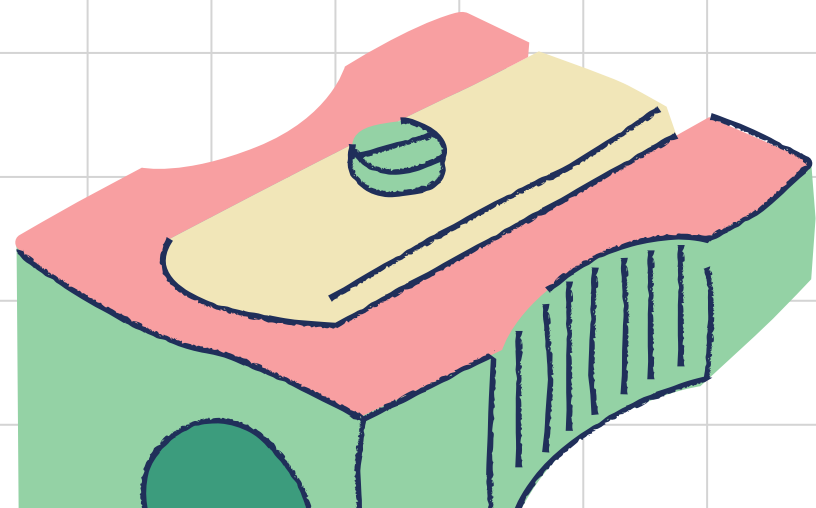

Let's think...

WHAT IS IT?

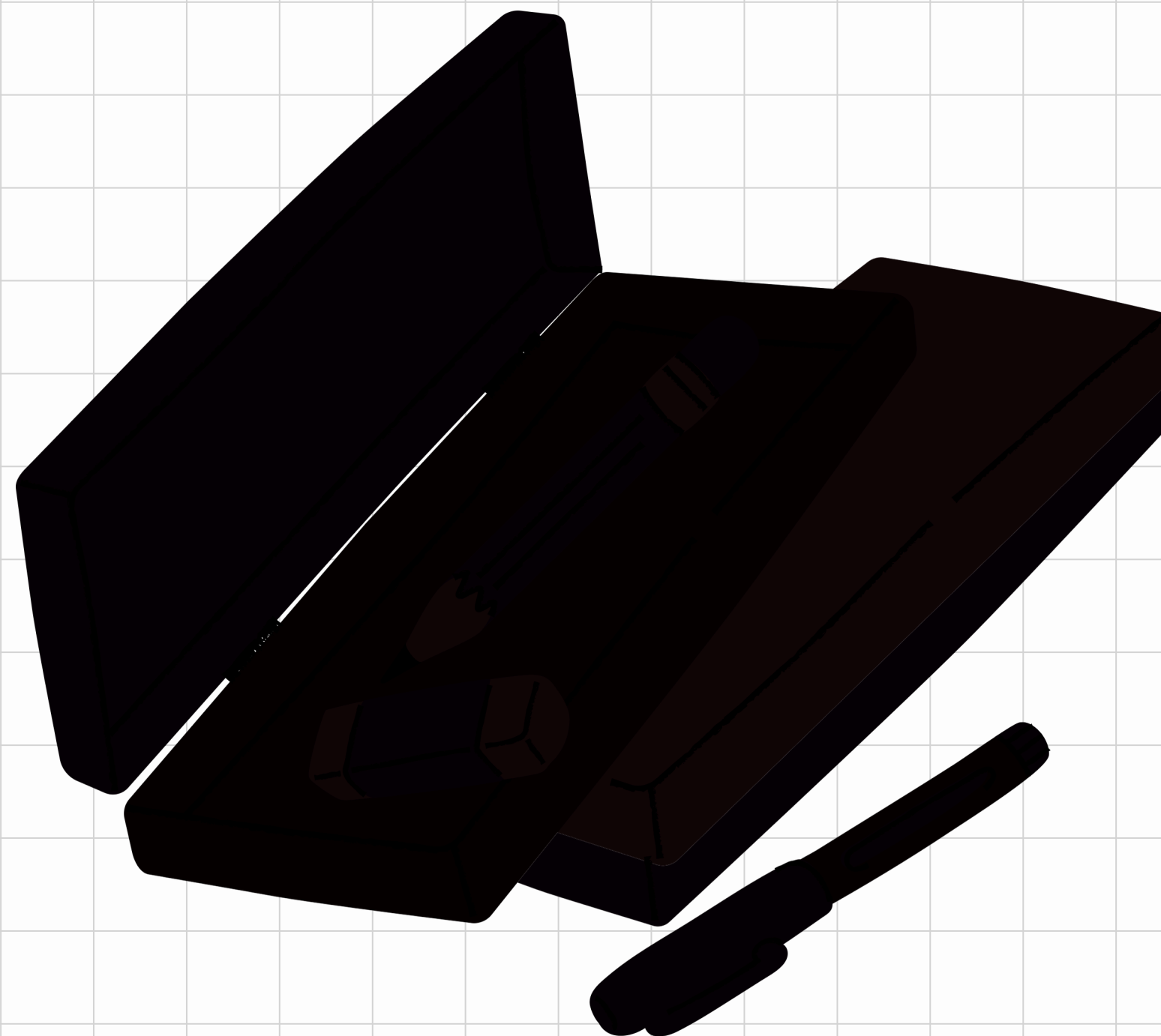

It is a pencil case.

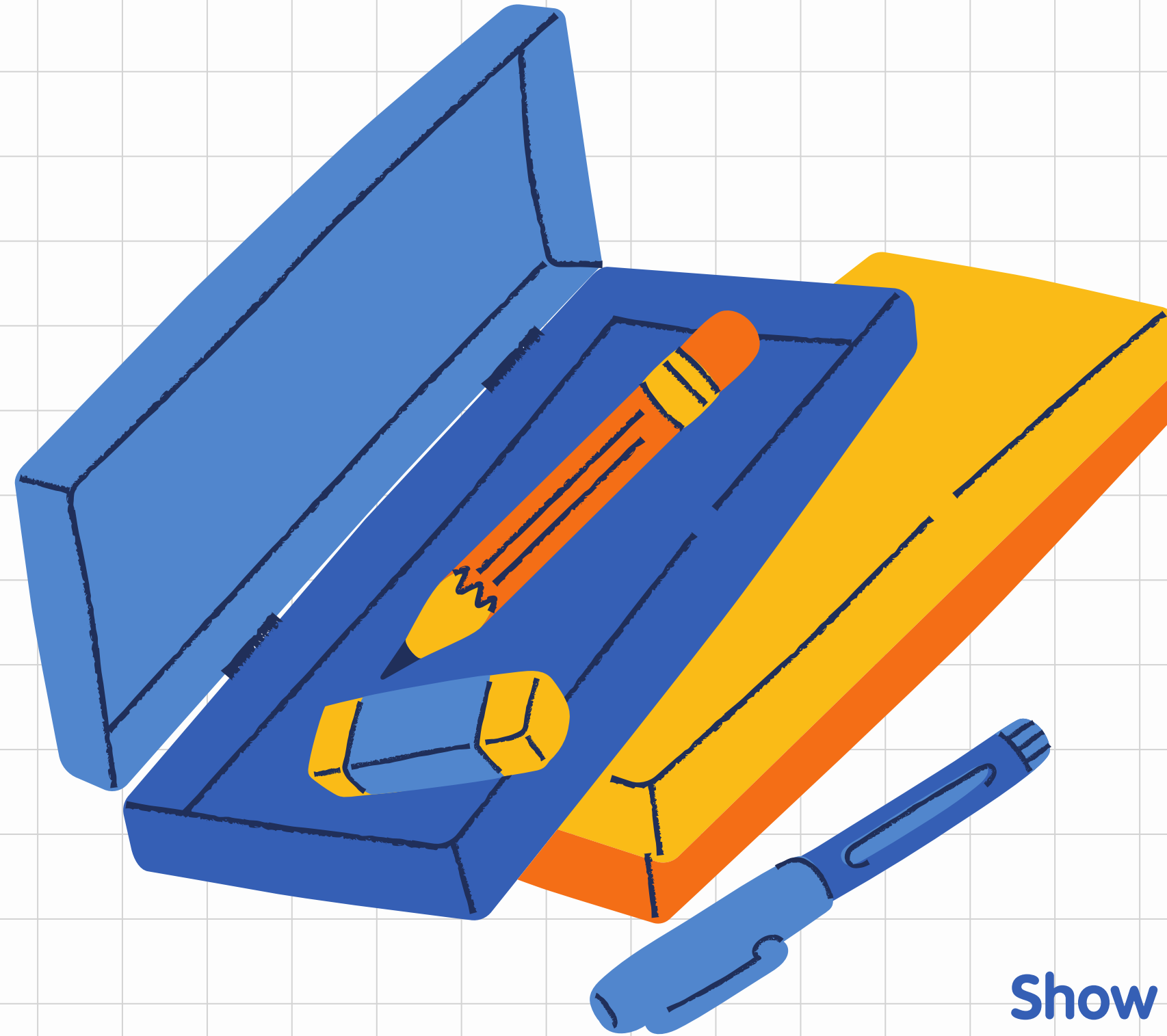

Show me your pencil case!

Let's think...

WHAT IS IT?

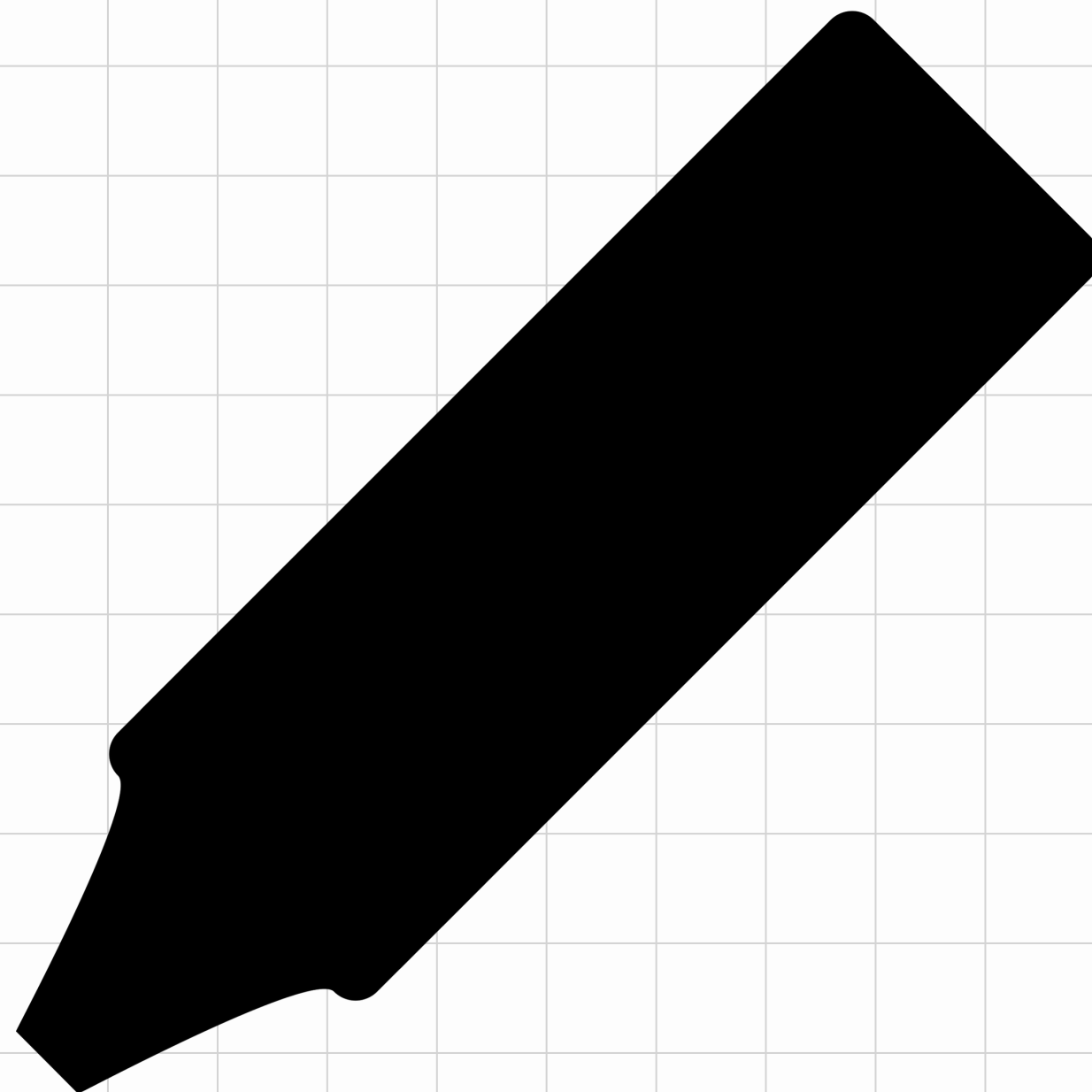

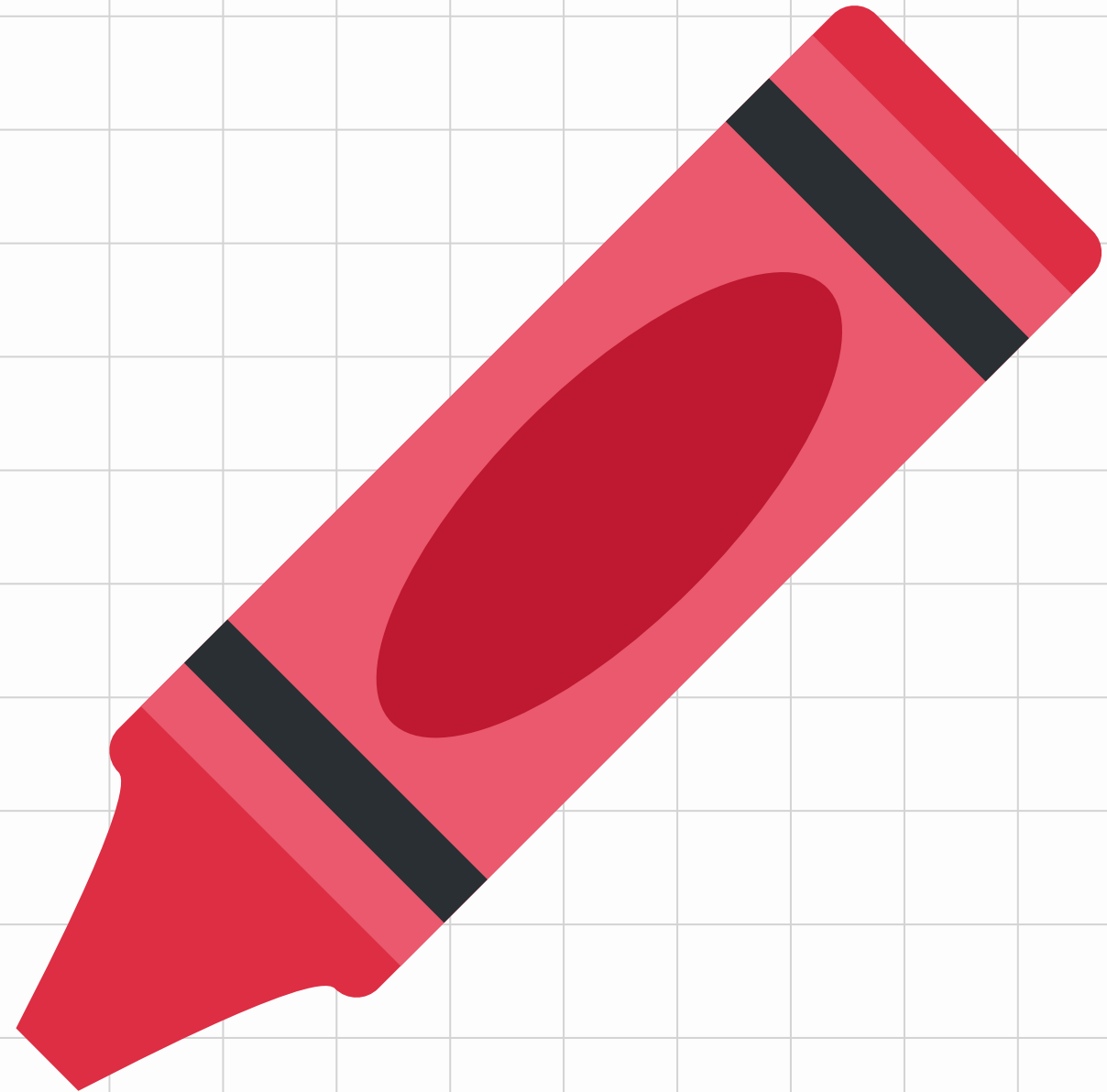

It is a crayon.

Show me your crayon!

Let's think...

WHAT IS IT?

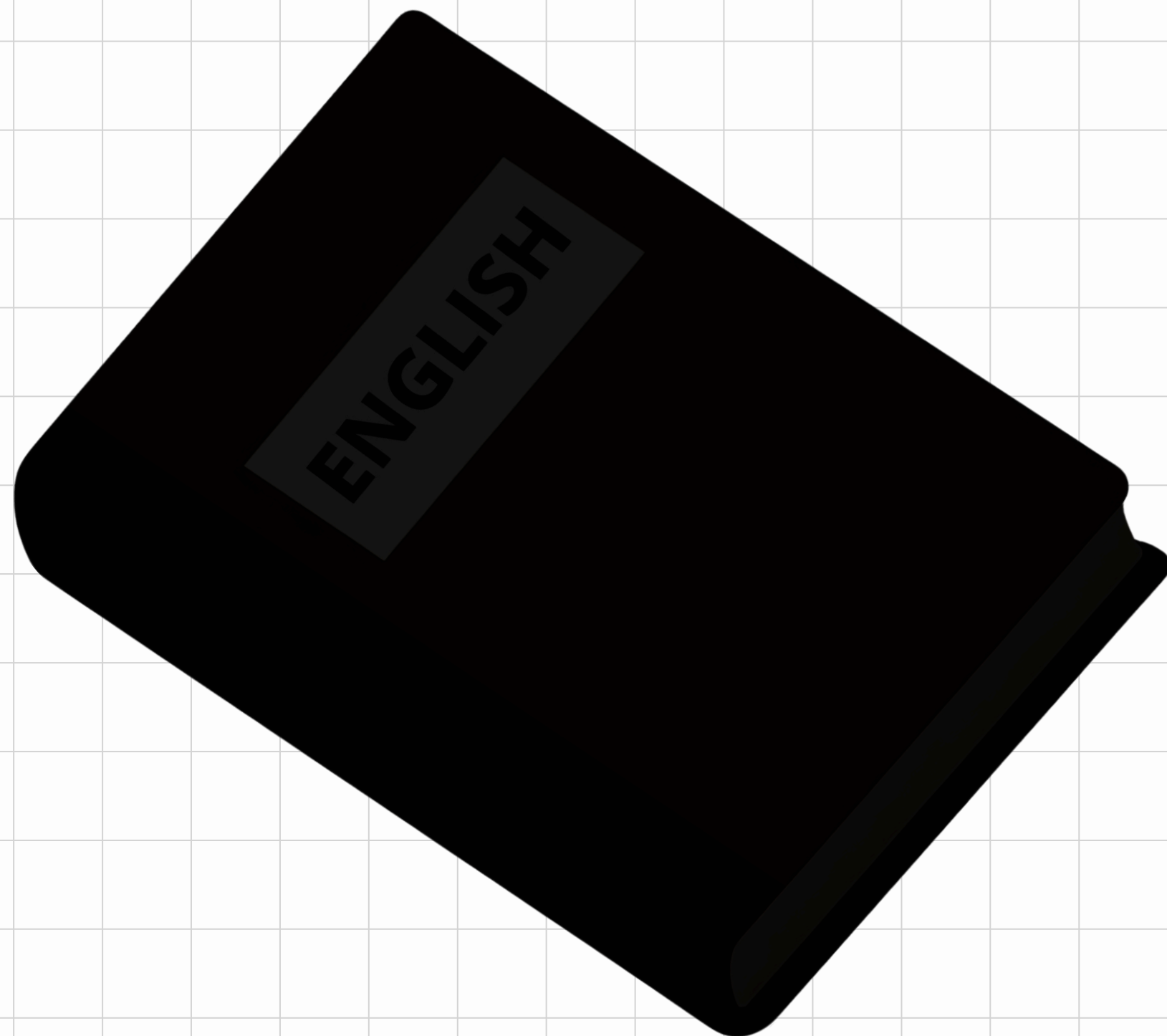



It is a book.

Show me your book!

Let's think...

WHAT IS IT?

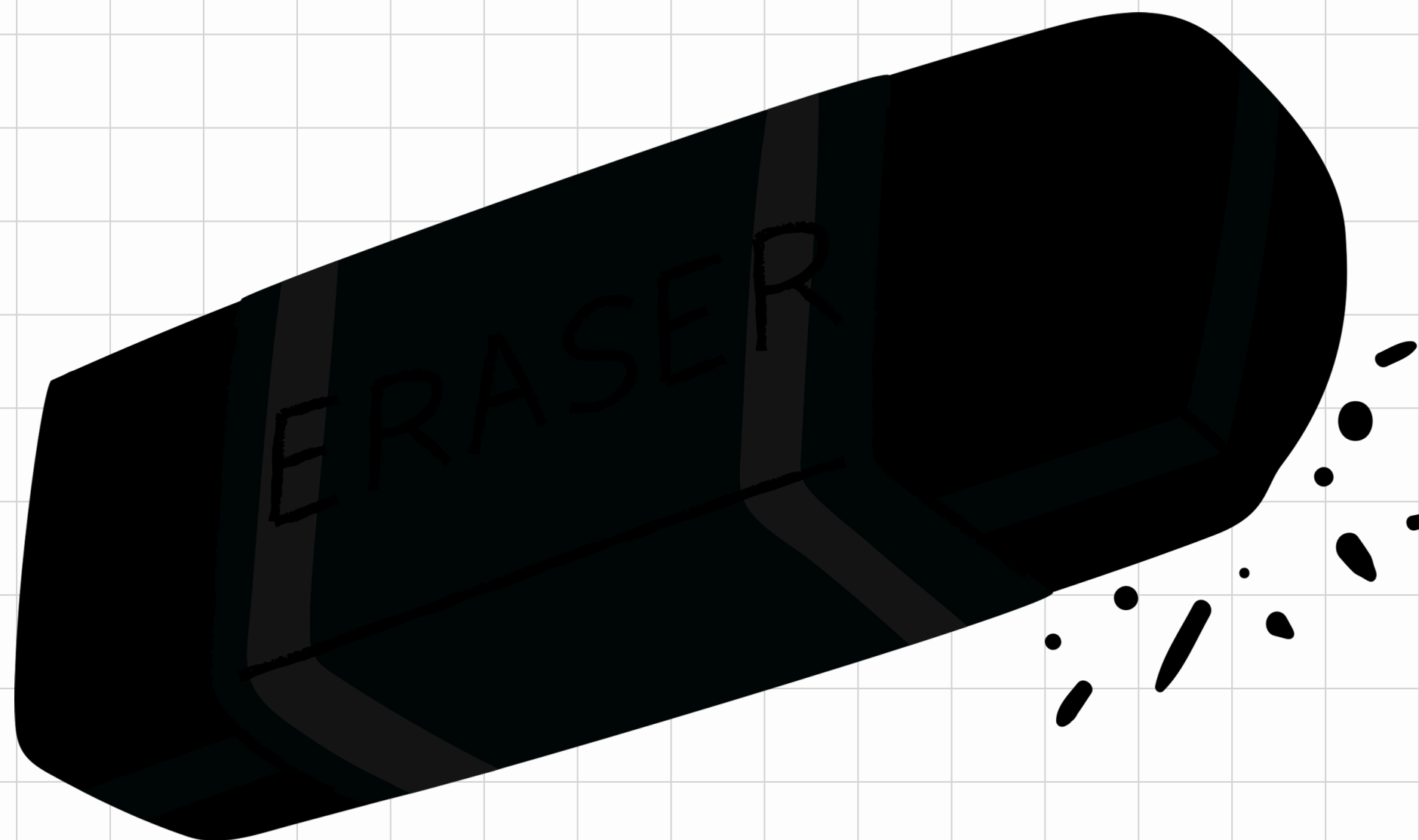

It is an eraser.

Show me your erasers!

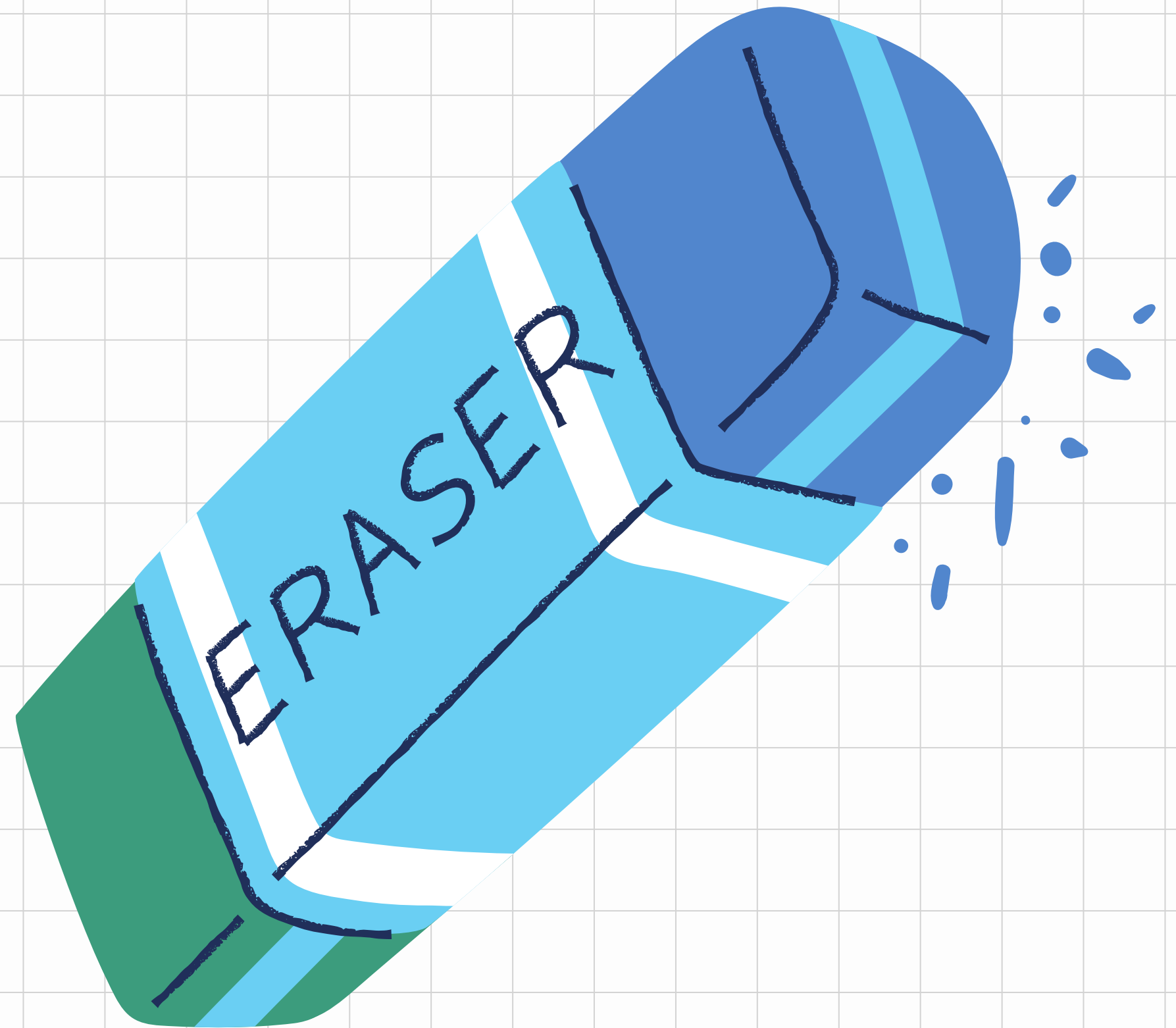

Let's think...

WHAT IS IT?





It is a glue.

Have you use your glue?

Let's think...

WHAT ARE THESE?

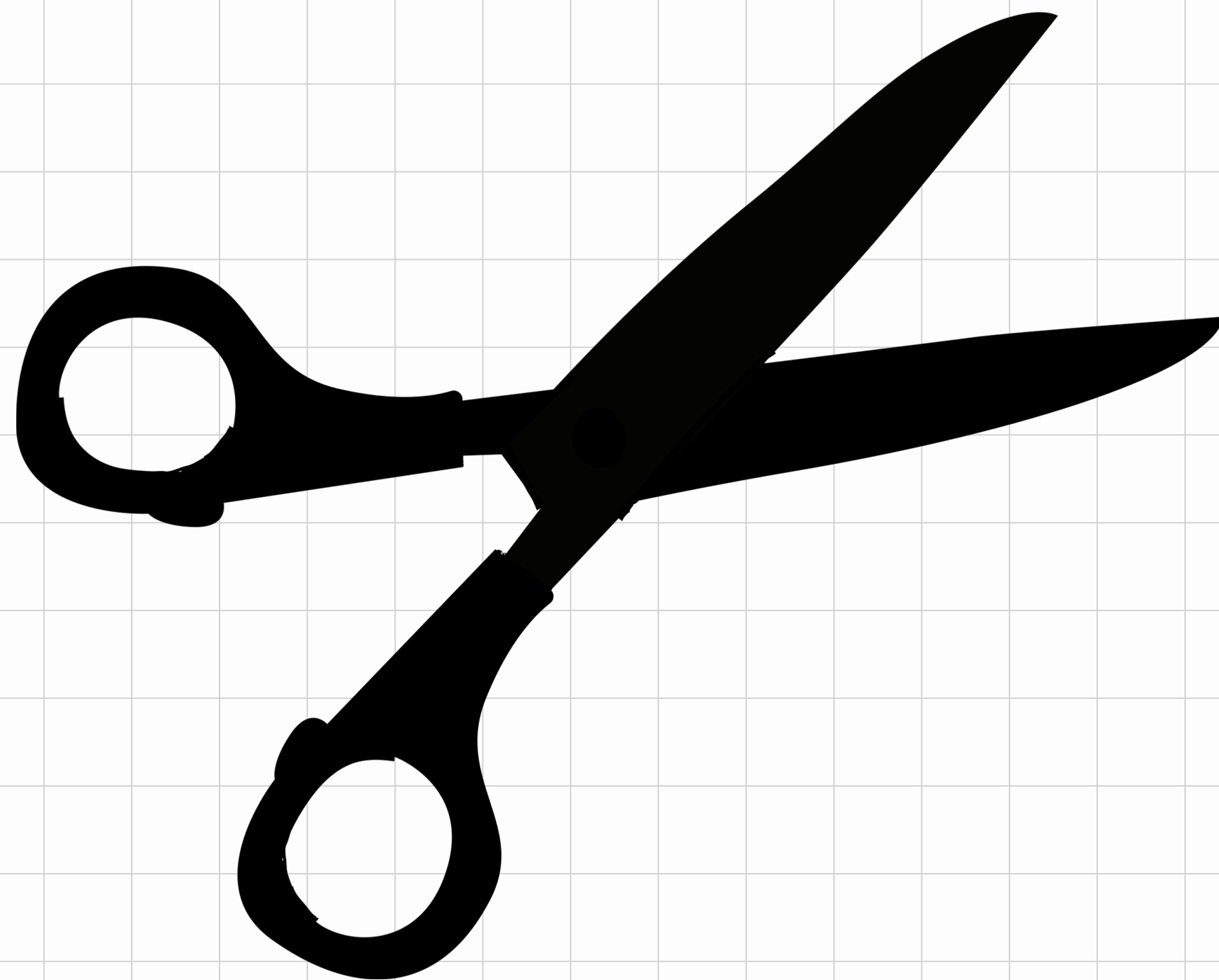

These are scissors.

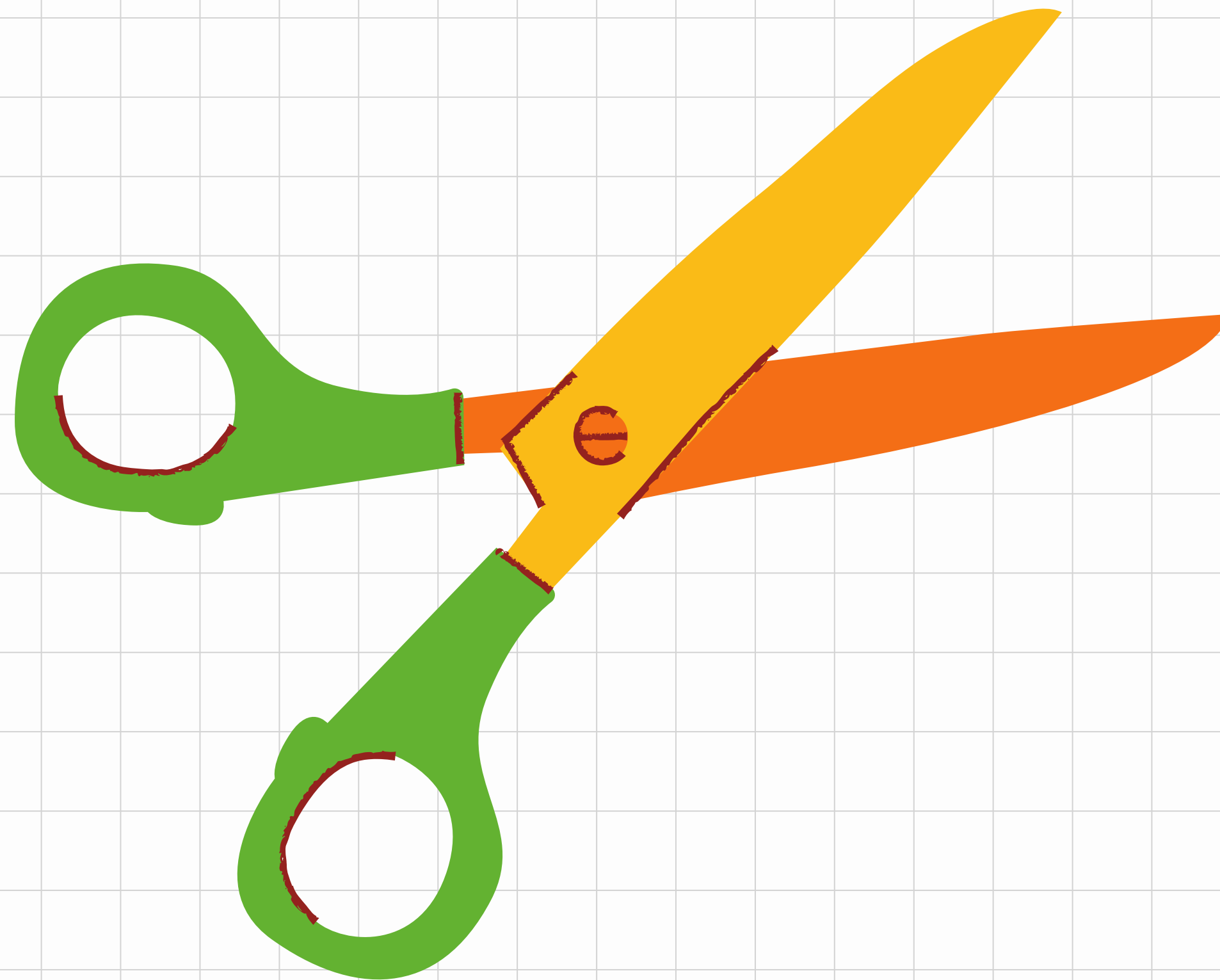

Show me your scissors!

Let's think...

WHAT IS IT?

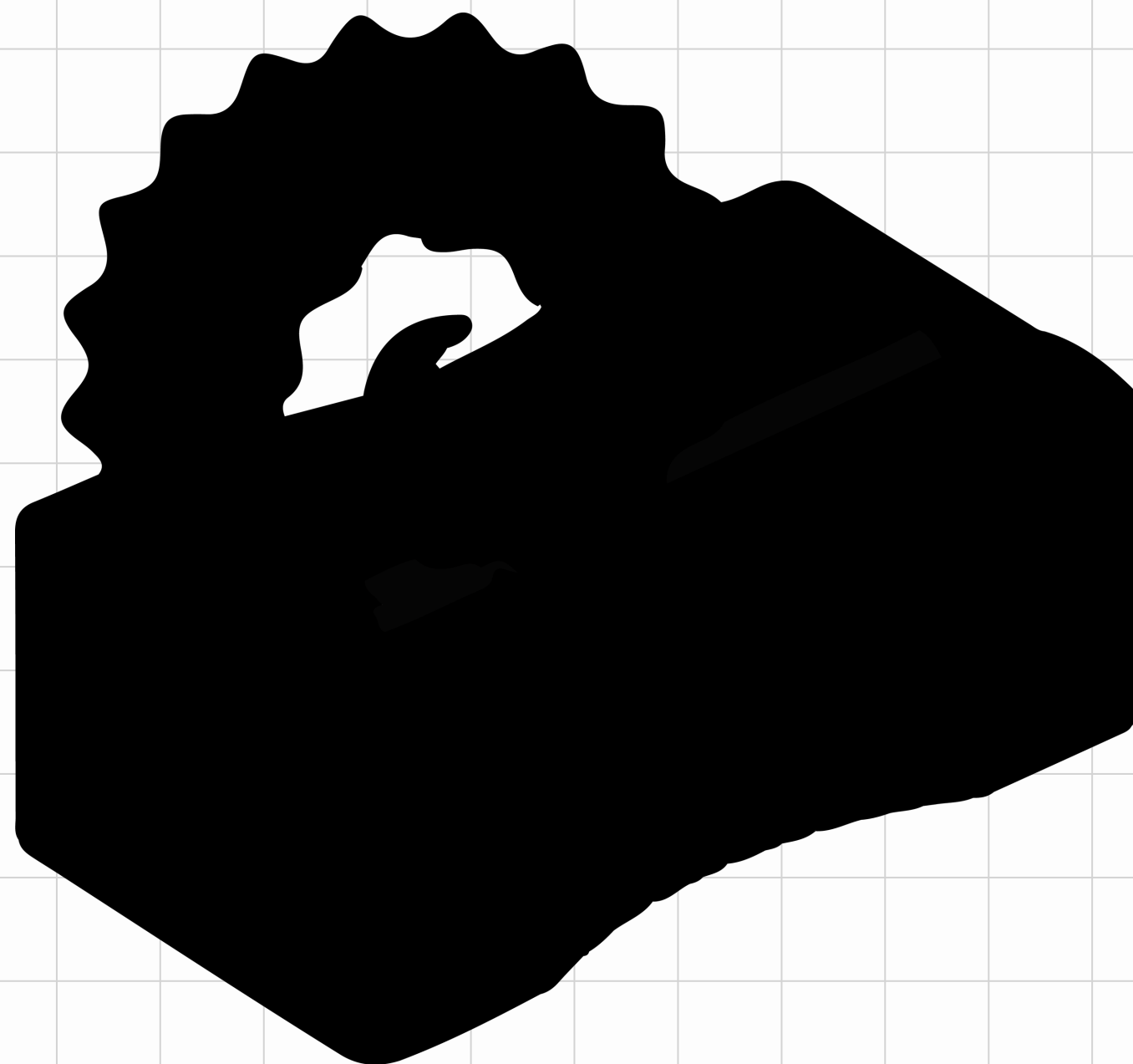

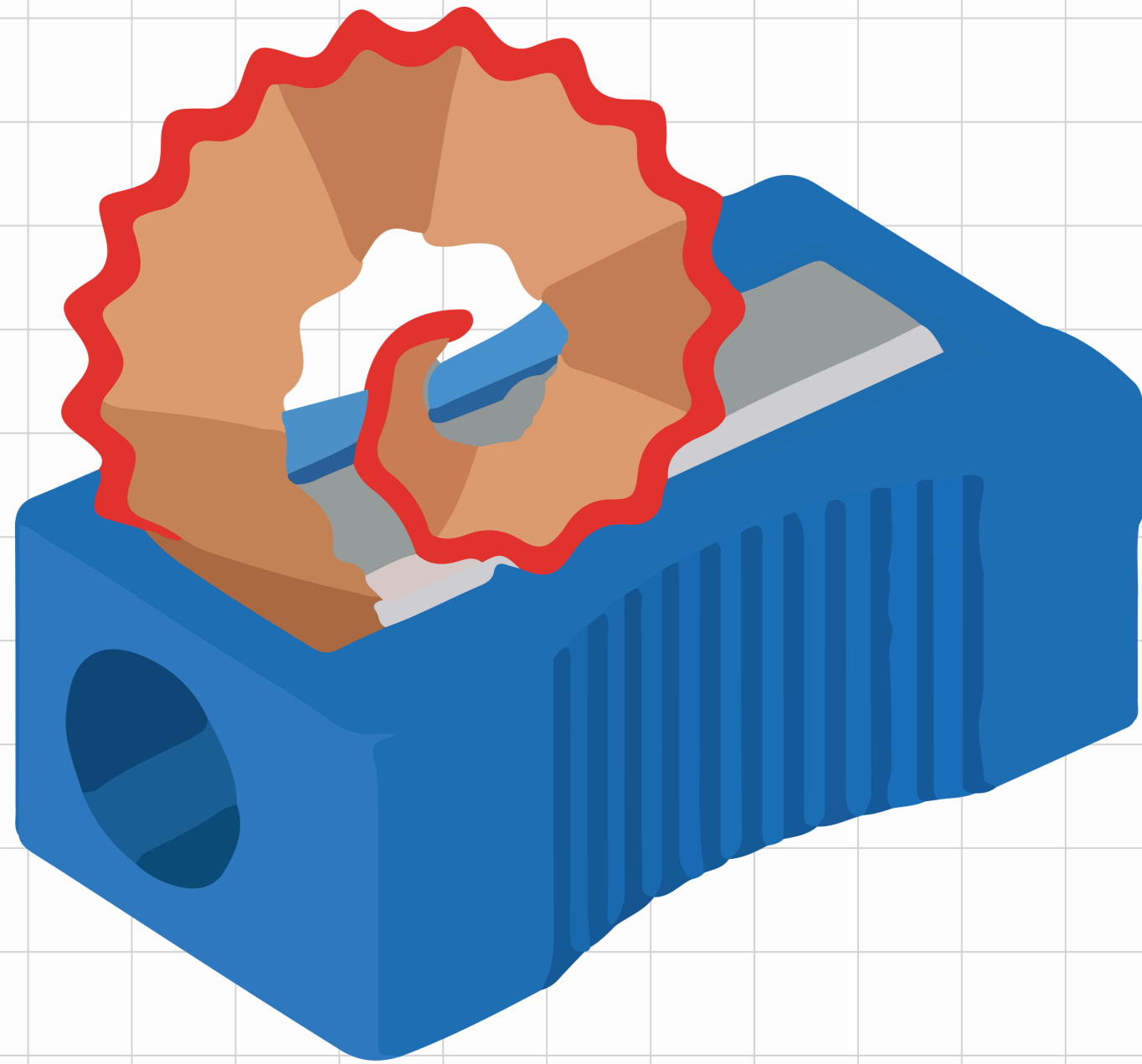

It is a pencil sharpener.

What color is your sharpener?

Let's think...

WHAT IS IT?

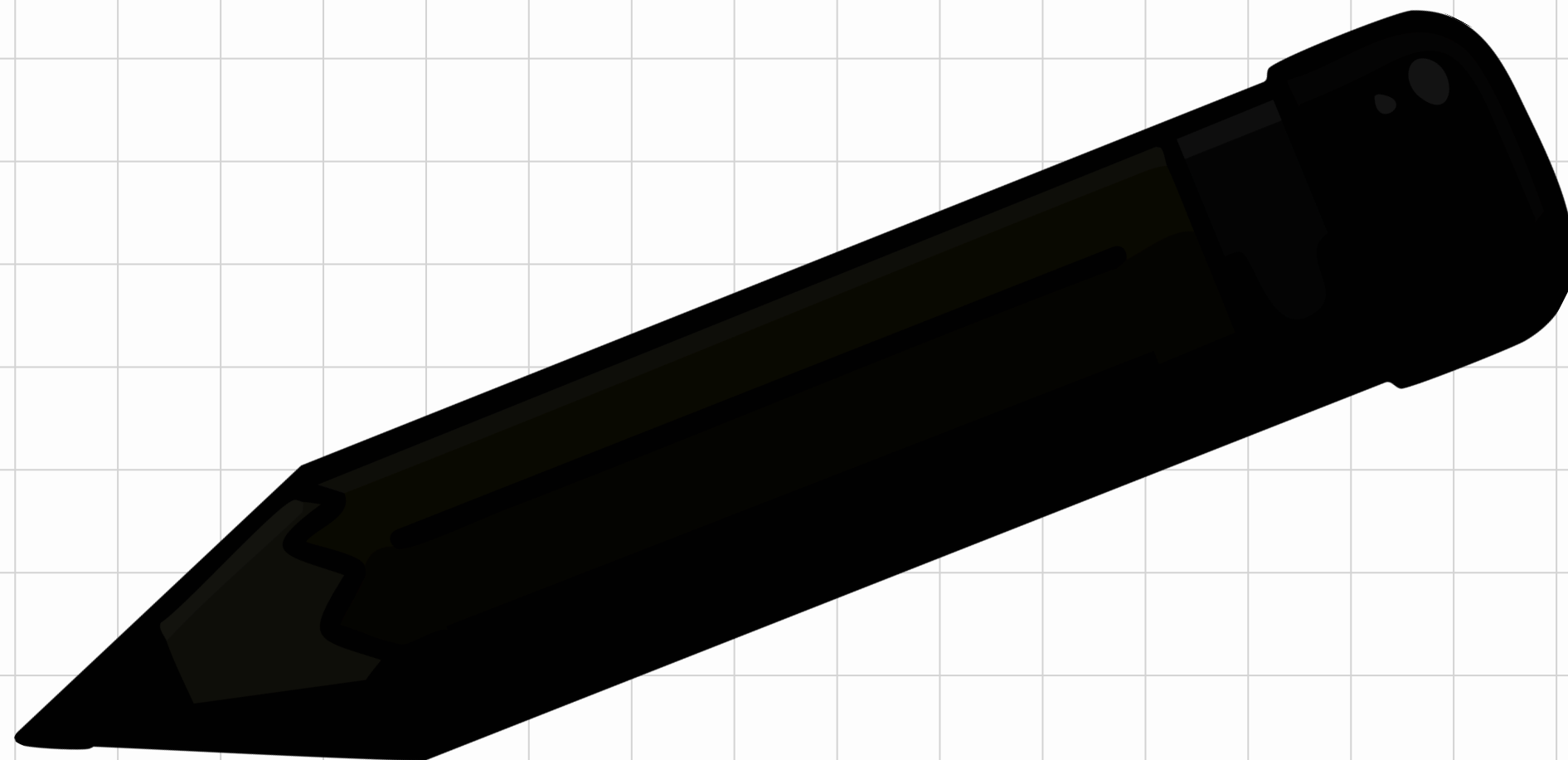

It is a pencil.

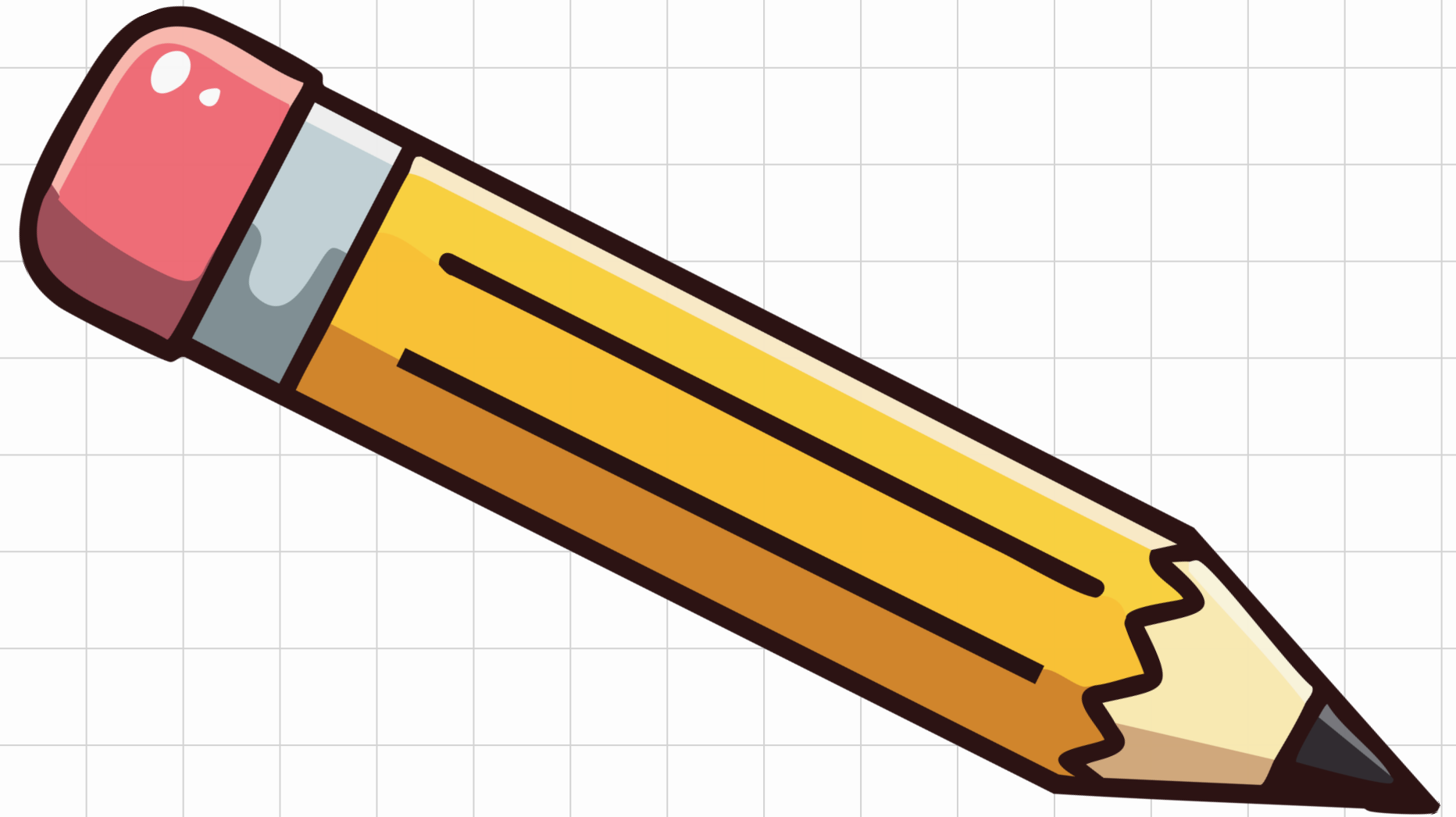

How many pencils do you have?

Let's think...

WHAT IS IT?

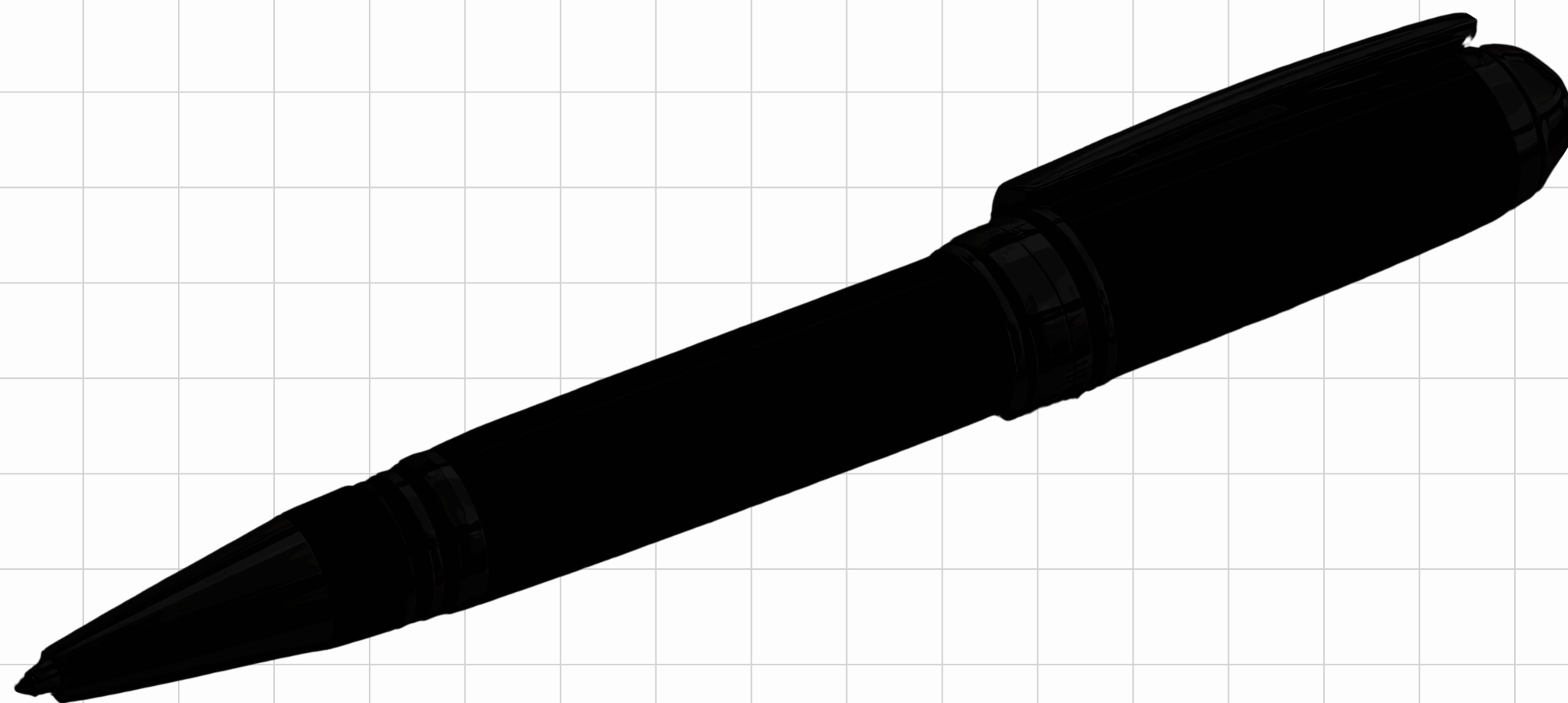



It is a pen.

How many pens do you have?

Let's think...

WHAT IS IT?

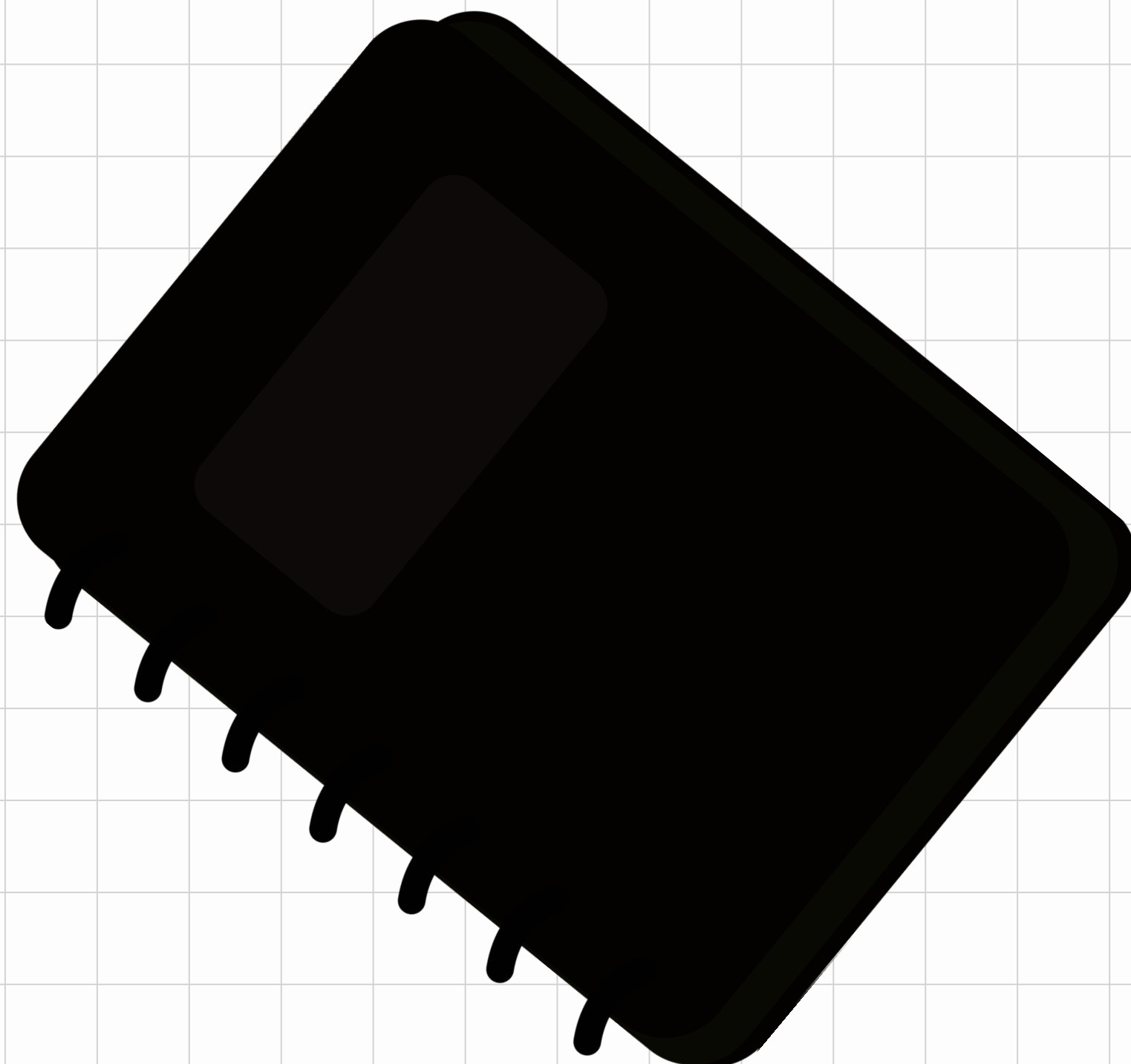

It is a notebook.

Show me your notebook?



Let's think...

WHAT IS IT?

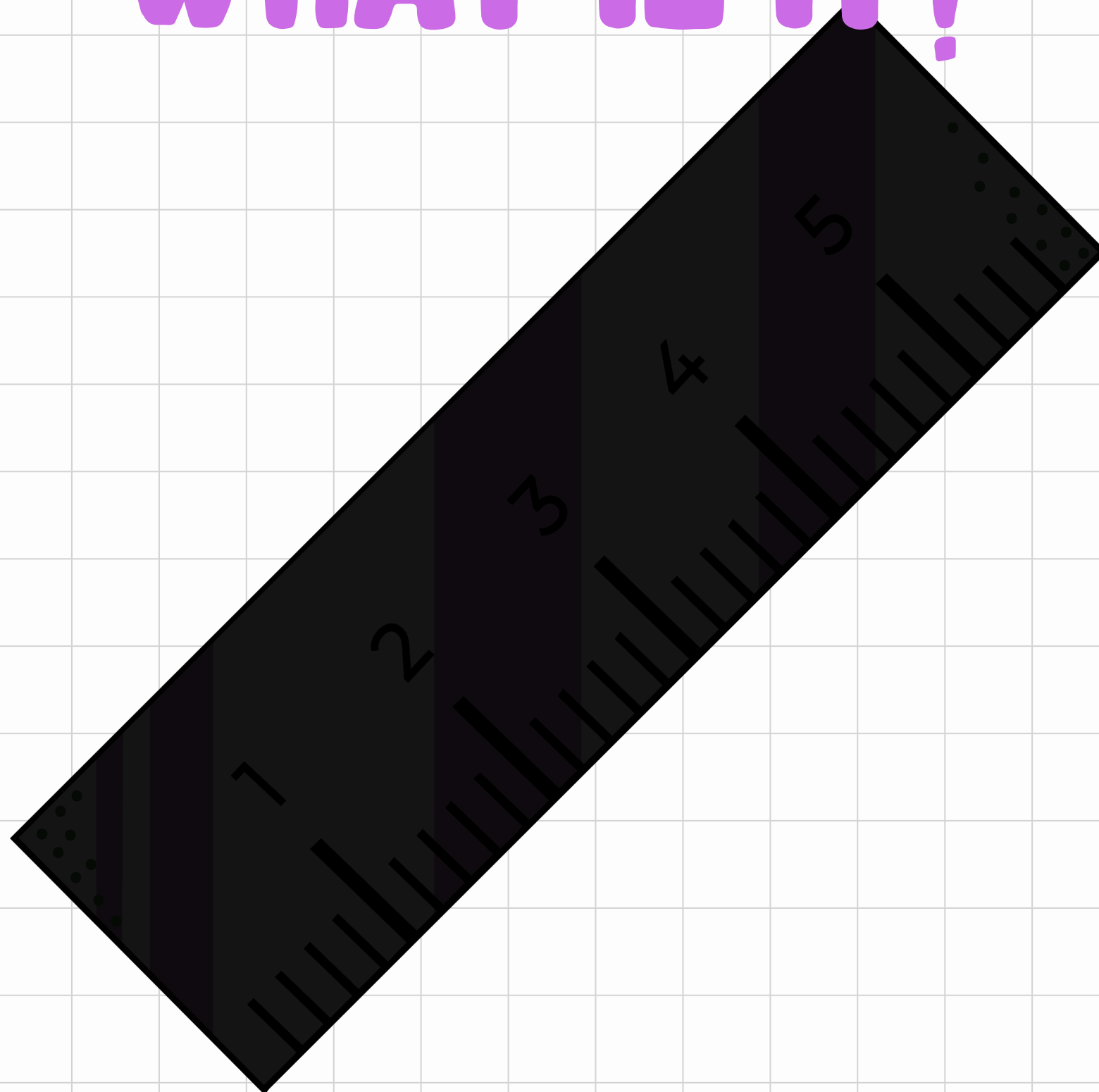

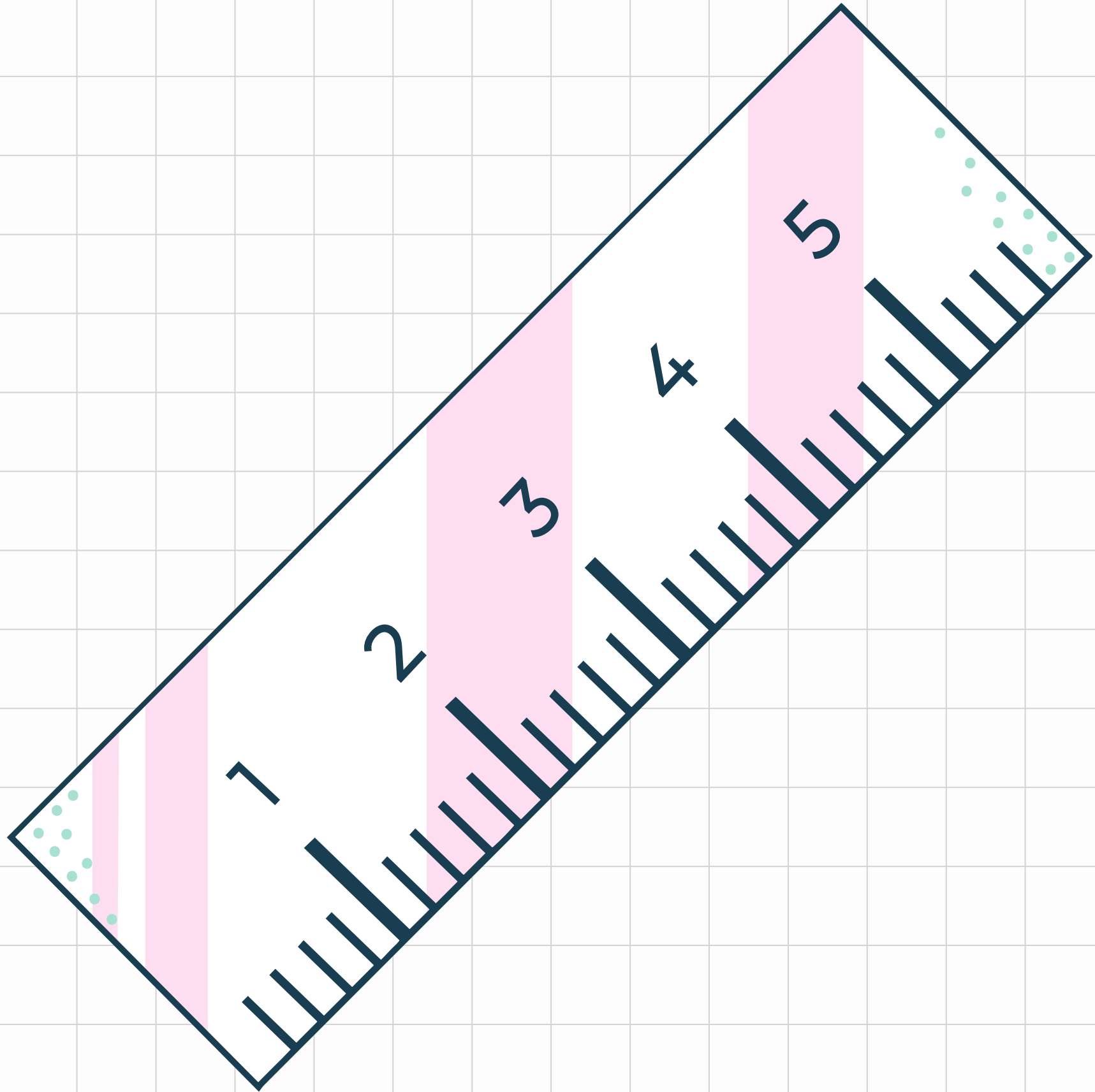

It is a ruler.

Show me your rulers!

Let's think...

WHAT IS IT?





It is a school bag.

Show me your school bag!

Let's think...

WHAT IS IT?

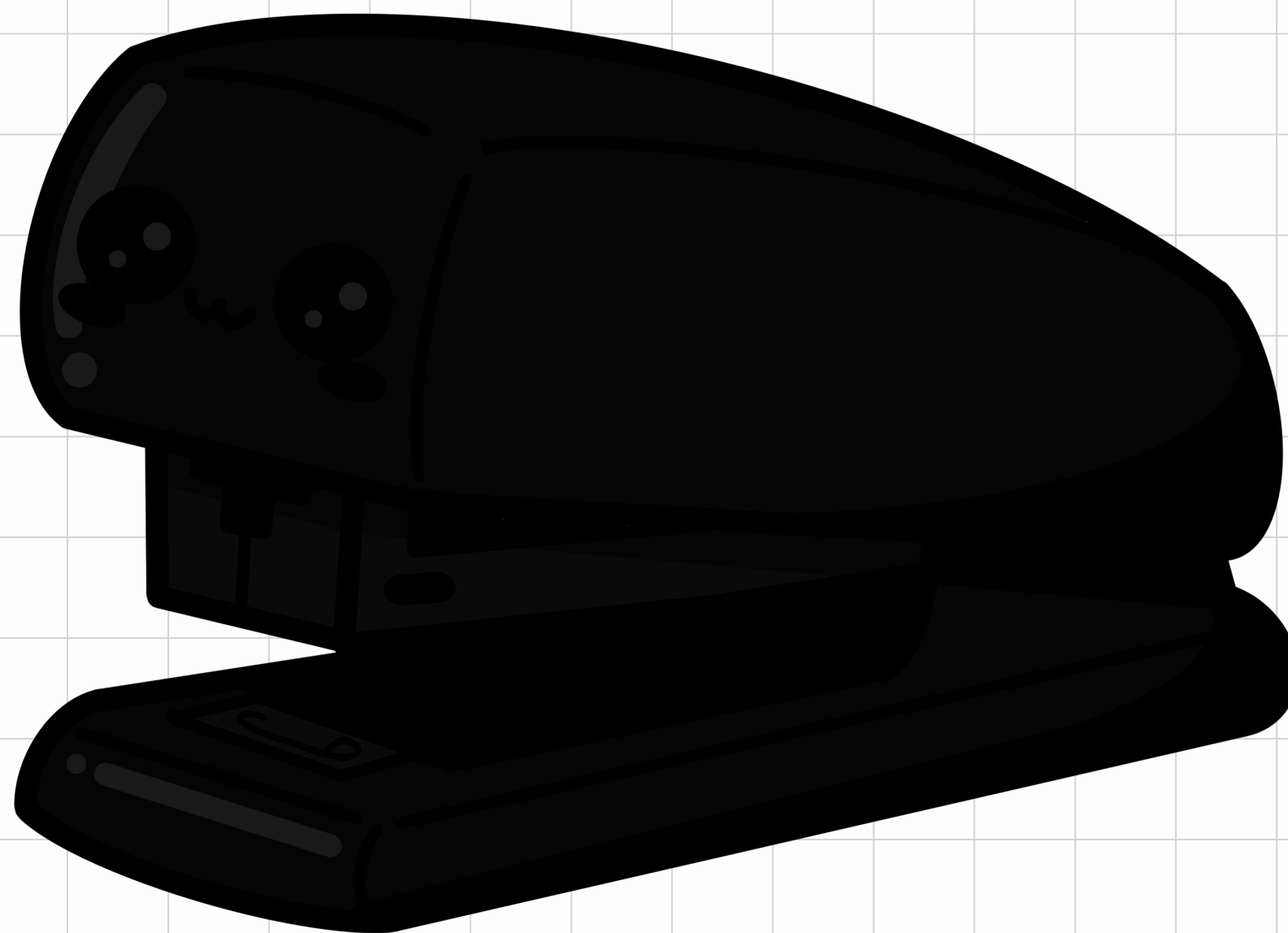

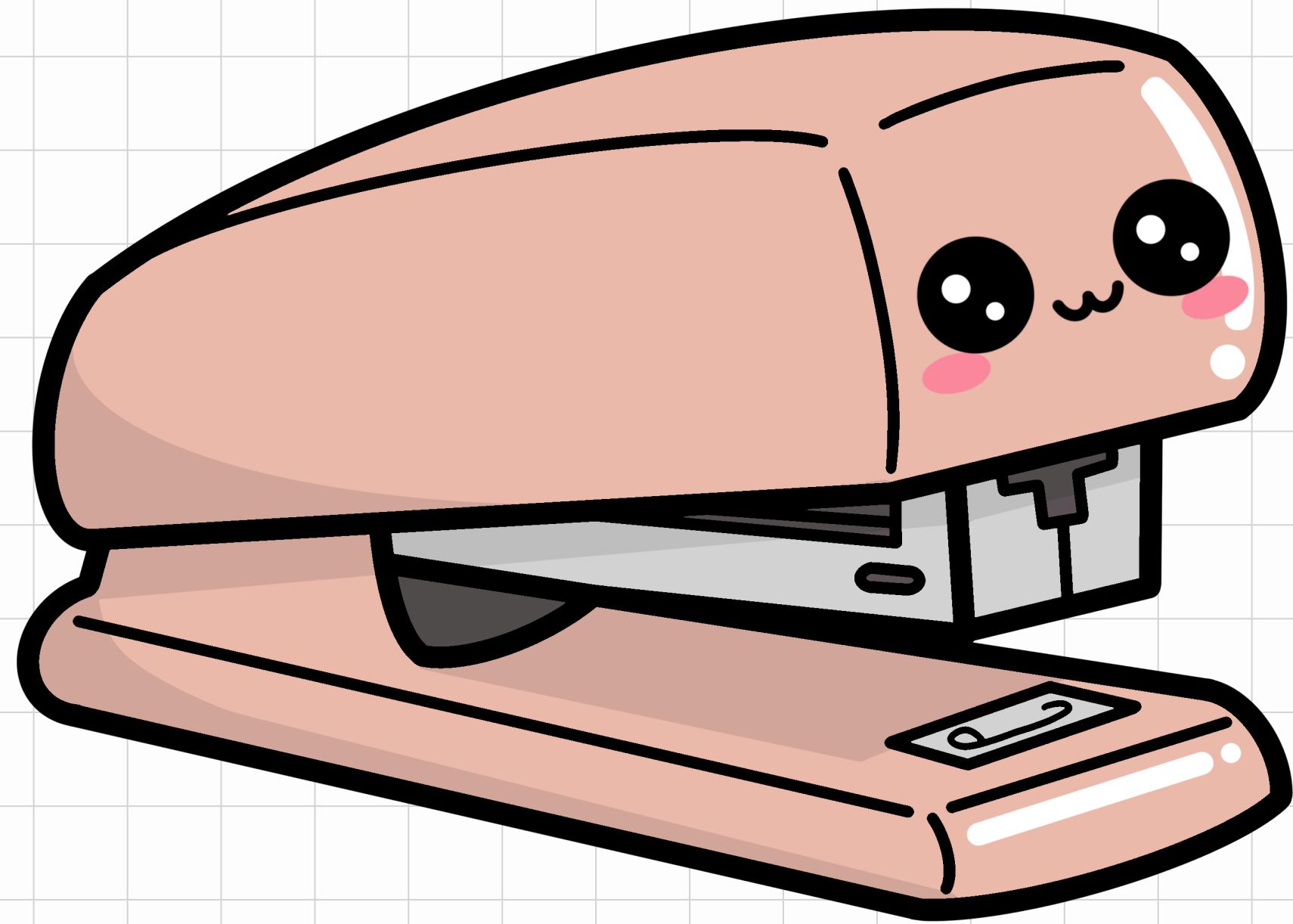

It is a stapler.

What color is your stapler!

Let's think...

WHAT IS IT?

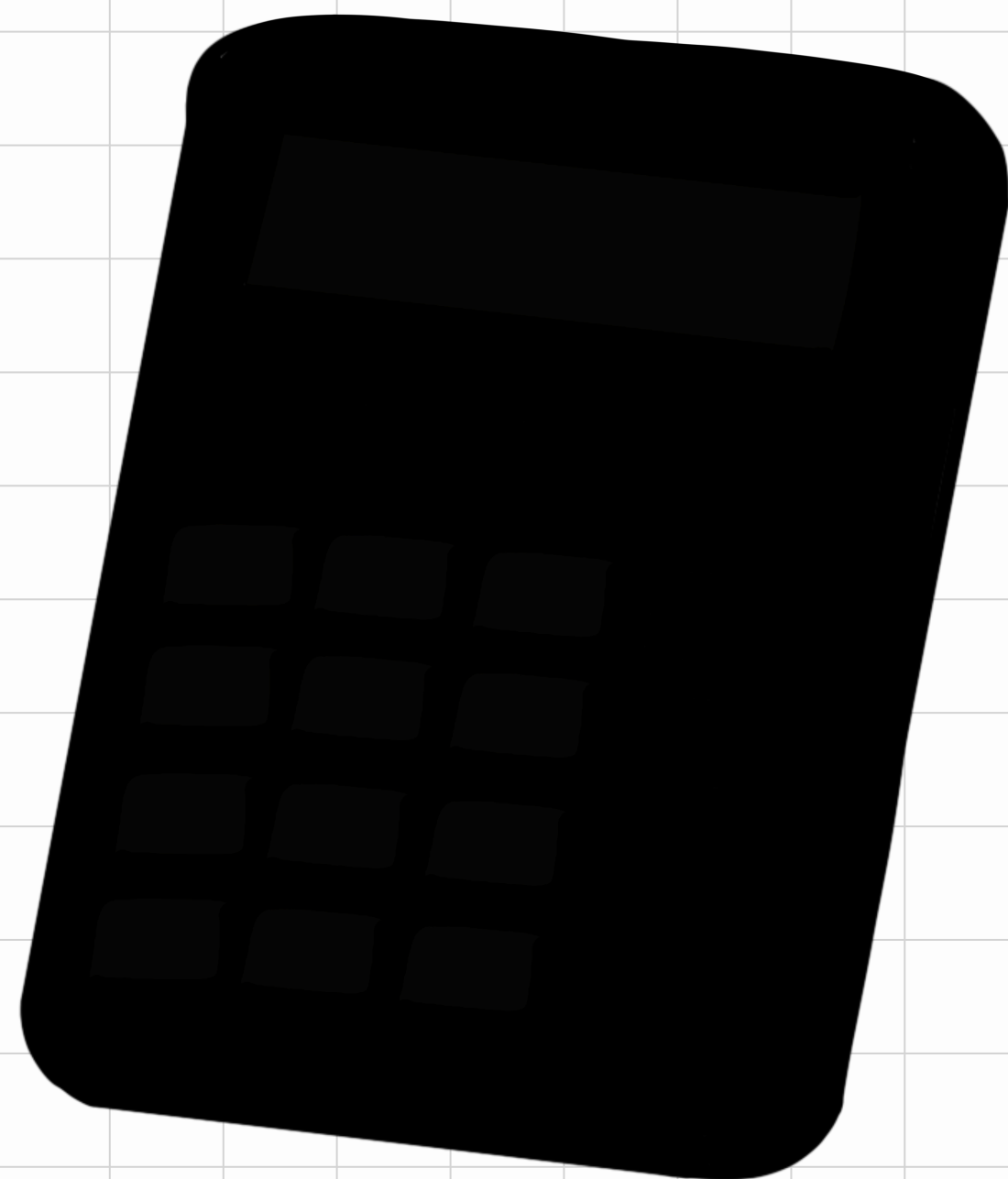



It is a calculator.

Do you have calculator!

Let's think...

WHAT IS IT?

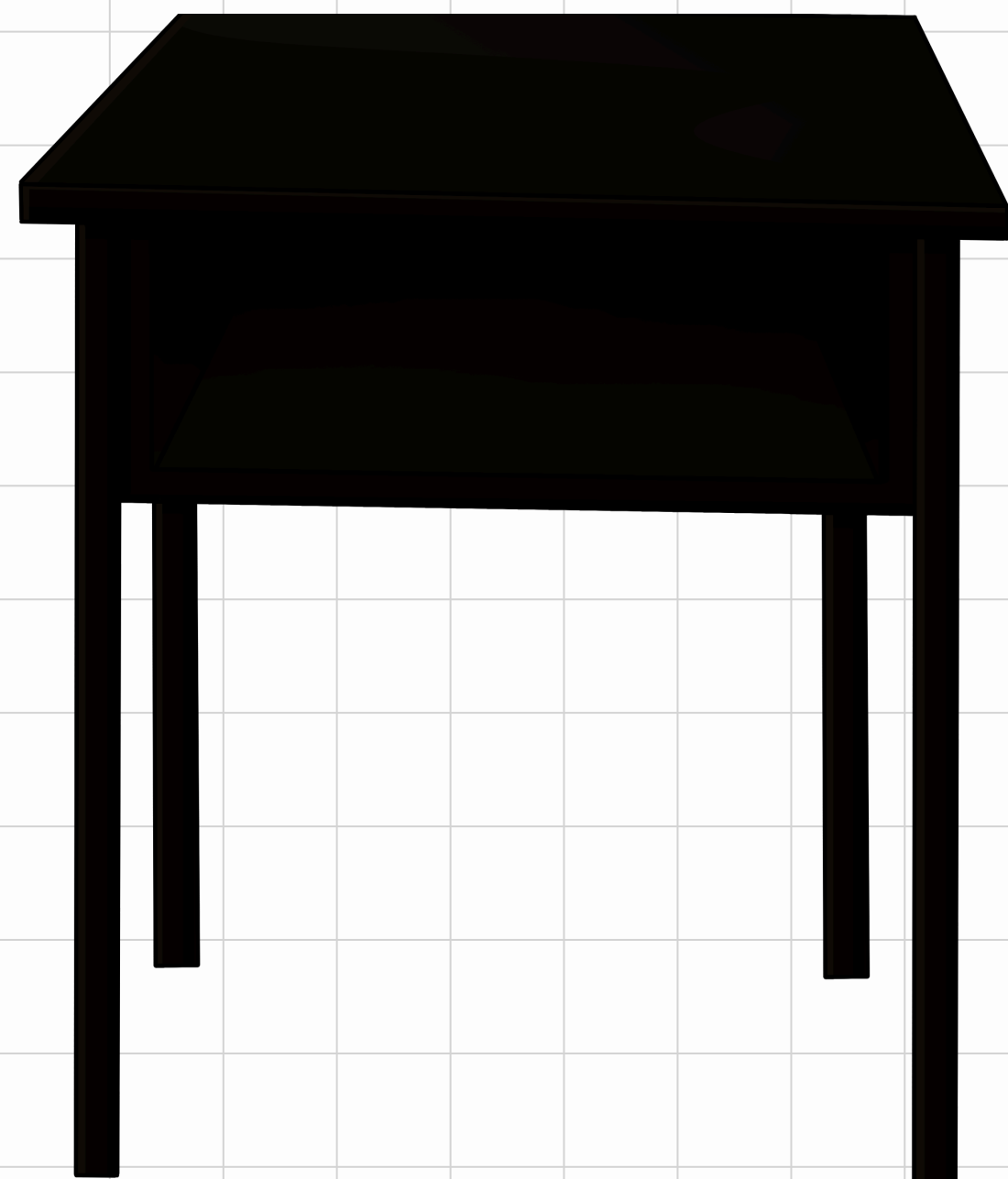

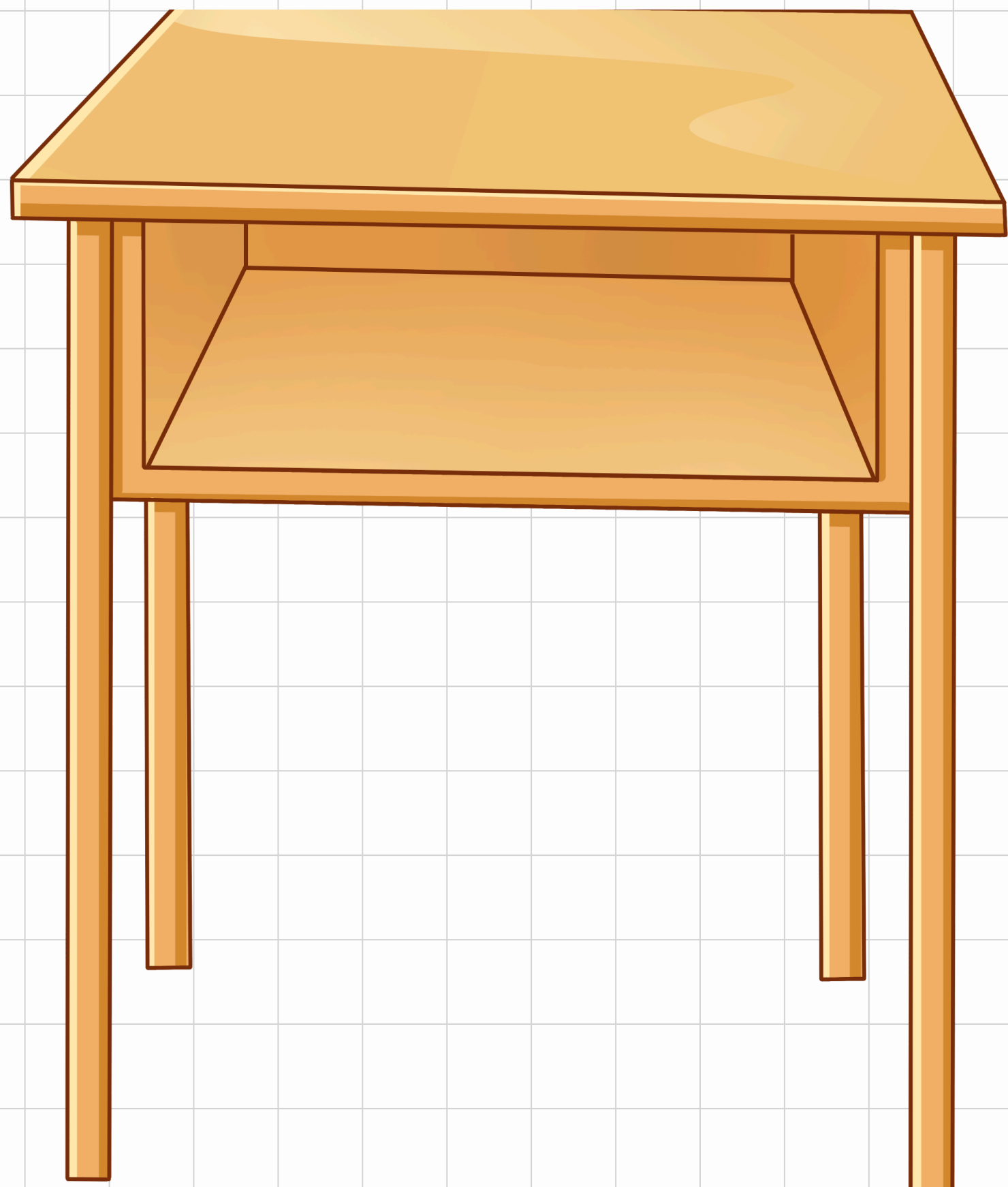

It is a desk.

Do you have a desk!

Let's think...

WHAT IS IT?

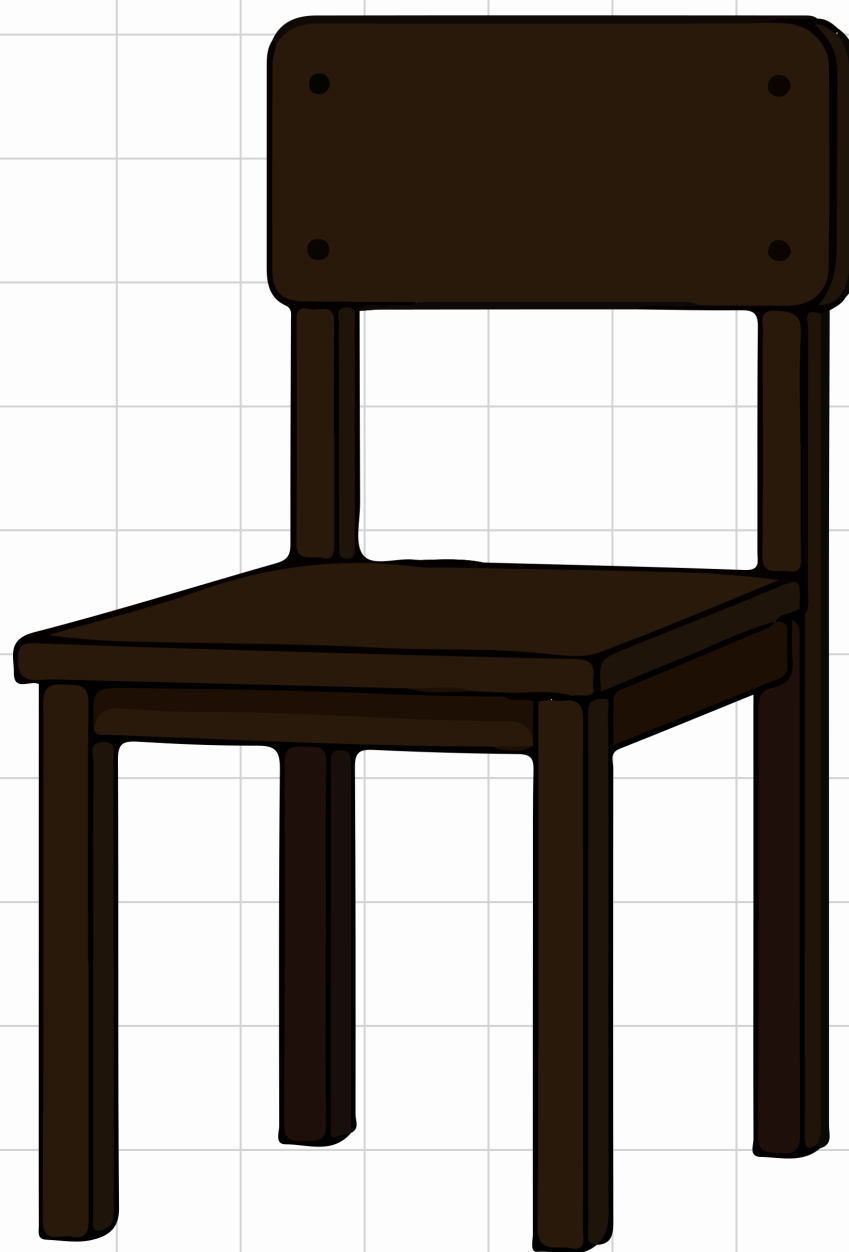

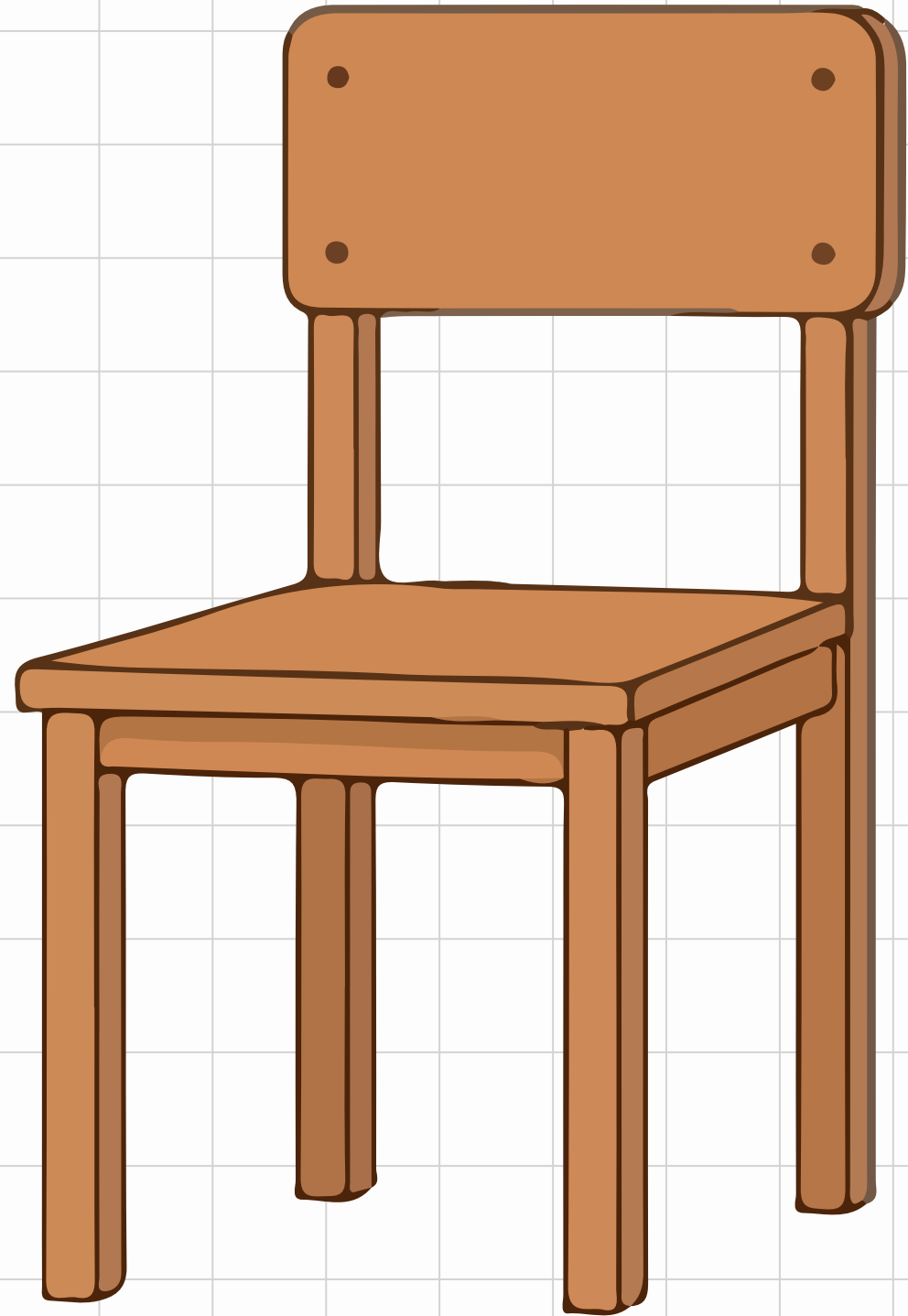

It is a chair.

How many chair do you have!

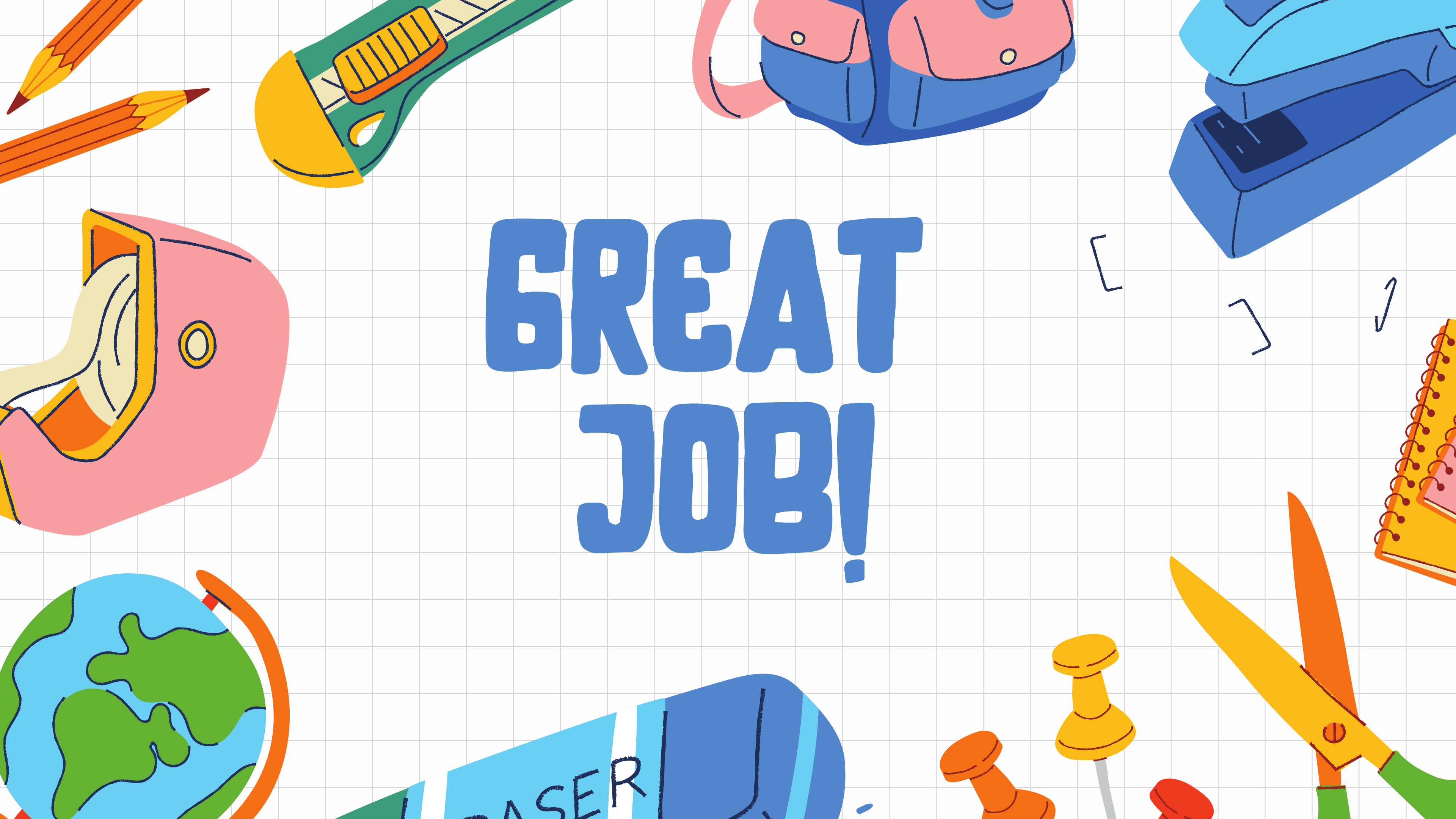

**GREAT
JOB!**